

Pendants

LD250PS-WBL
White/Black

A larger version of the LD240PS. Lamping and colour options are available to solve many lighting problems.



LD250PS-GBS
Grey/Brushed Steel



Related Models

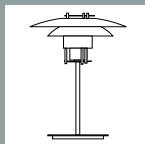

LD240T

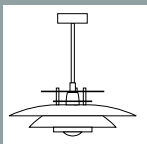

LD240PS

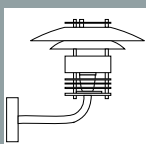

LD230EW

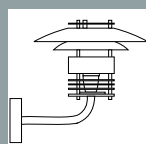

LD240EW

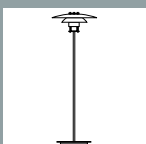

LD250FL

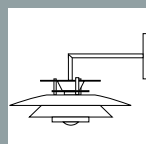

LD240WM

Technical Specifications

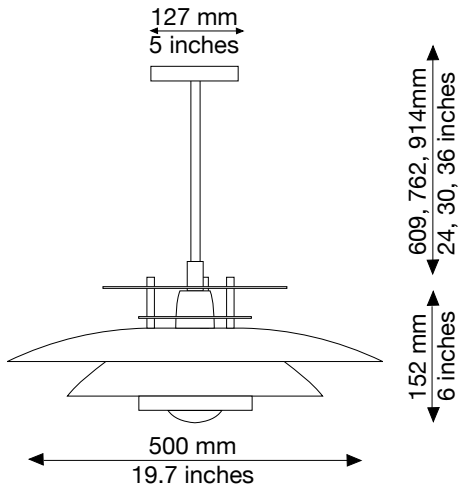

Lamping for Pendant Stem (PS)			
Source	Ballast	Voltages	Restrictions
Inc 100W	none	120	
CFL up to 32W	electronic	All voltages	2" x 6" Ceiling Canopy Required
Metal Halide up to 50W	electronic	120, 277	2" x 6" Ceiling Canopy Required

Colours:

White/White –WW

White/Black-WBL

White/Brushed Steel-WBS

Grey/Brushed Steel-GBS

Custom/Custom-CC (See options on page 3, specify requirements at time of quotation for accurate pricing)

Options:

Hang Straight-HS

Part Number Example:

LD-250PS Pendant, White with White Accents, Compact Fluorescent 32W, 277 Volts, Hang Straight.

Part number as follows:

LD-250PS-WW-CF32W-277-HS

Model	—LD250PS	WW	CF32W	277	HS
Colour	_____	_____	_____	_____	_____
Source	_____	_____	_____	_____	_____
Voltage	_____	_____	_____	_____	_____
Option	_____	_____	_____	_____	_____